

ESi STRATUS

Wi-Fi Wireless Programmable Room Thermostat With Heating & Hot Water Control

ESRTP6B

User Instructions



Quick Reference Guide

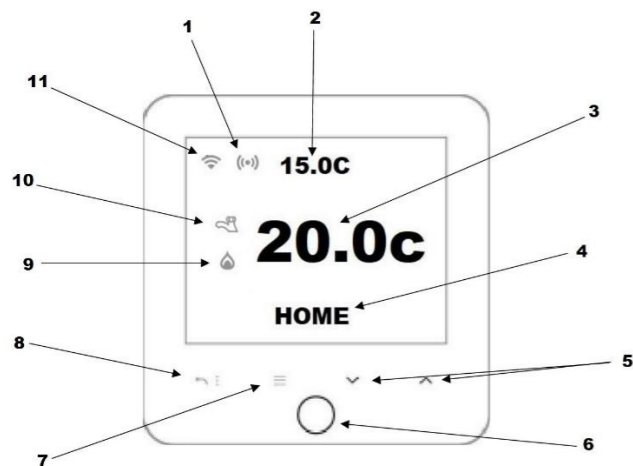

1. RF Connection Status
2. SET Temperature
3. ROOM Temperature
4. MODE Display
5. UP/DOWN Arrows
 - Temperature change
 - Navigate through menus
 - Change settings
6. HOME Button
 - Select options in menus
 - Change settings
7. MENU Button
 - Access menus & sub-menus
8. Return Button
 - Return to Home or previous screen
9. Flame Icon
 - Indicates heating is on
10. Tap Icon
 - Indicates hot water is on
11. Wi-Fi Connection Status

Setting The Time & Date

If your thermostat is **not** connected to your home Wi-Fi, you will need to follow these steps during initial setup & after a power outage.



Press **HOME** to wake the display. Press **MENU** & use **LV** to show SET TIME. Press **HOME** & use **LV** to choose either 12 or 24 hour clock. Press **HOME**



Use **LV** to change the hours then press **HOME** to move onto the minutes. Use **LV** to change the minutes. Press **HOME** to save.



Press **HOME** to enter the date settings. Use **LV** to change the date & **HOME** to move to the next digits.



Press **SELECT** to save your settings.

Heating Mode

To change the heating mode, tap the **HOME** button until the desired heating mode is selected:

- **HOME** – Programs will run.
- **MANUAL** – Manual mode will maintain the SET temperature constantly.
- **AWAY** – Away mode sets the user defined Away temperature. This is a permanent setting until the mode is changed.
- **SLEEP** – Sleep mode sets the user defined Sleep temperature. This mode will continue until the first program of the following day.

Setting Sleep & Away Temperatures

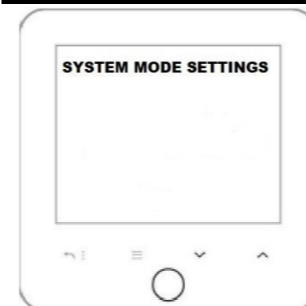

Press **HOME** to wake the display. Press **MENU** & use **LV** until you see SYSTEM MODE SETTINGS. Press **HOME**. Use **LV** to choose either SLEEP or AWAY then press **HOME**.

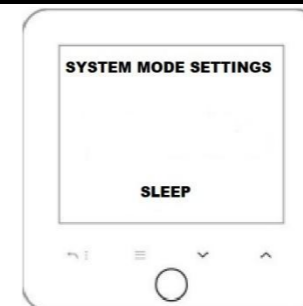

Use **LV** to set your preferred SLEEP or AWAY temperature. Press **HOME** to save & use the **RETURN BUTTON** to exit the menu.

Temporary Override – Heating

When your ESi STRATUS is in HOME mode, you can temporarily override the current SET temperature by using the **LV** buttons. The temporary override will end when the next program starts which is indicated by the 'TO' time.



Temporary Override – Hot Water



Wake the display by pressing the **HOME** button. Touch & Hold the **HOME** button until HOT WATER BOOST is displayed. Use the **LV** buttons to select the desired setting. Press **HOME** to save your setting & use the **RETURN BUTTON** to get back to your HOME SCREEN.

Choose A Heating/Hot Water Schedule

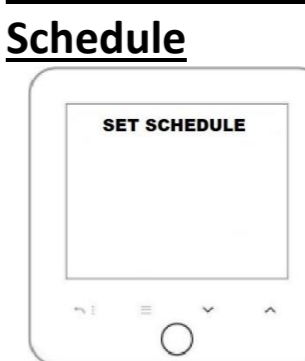

Press **HOME** to wake the display. Press **MENU** & use **LV** to navigate to SET SCHEDULE. Use **LV** to choose either HEATING or HOT WATER

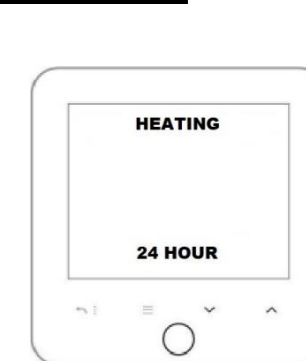

Press **HOME** & use **LV** to choose a schedule. Press **HOME** to save. There are 3 schedules to choose from: 7 Day 24 Hour or 5-2 Day.

- 7 Day** – Different programs for each day. Every day will need to be set independently.
- 24 Hour** – Every day will run the same programs.
- 5-2 Day** – One program for weekdays with a different program for weekends.

Setting Heating Programs

Your ESi STATUS has a pre-set heating profile as shown below, which you can change to your own heating programs.

	EVENT	Time	Temp	EVENT	Time	Temp	
Week Days	1	06:00 - 08:00	20°C	Weekends	1	07:30 - 09:30	20°C
	2	08:00 - 17:00	15°C		2	09:30 - 16:30	20°C
	4	17:00 - 22:00	21°C		4	16:30 - 22:30	21°C
	5	22:00 - 06:00	15°C	5	22:30 - 07:30	15°C	

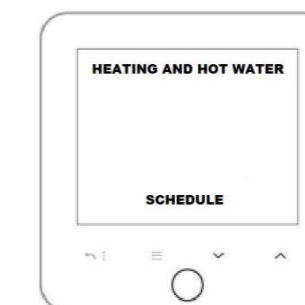

Press **HOME** to wake the the display. Press **MENU** and use **LV** to navigate to HEATING AND HOT WATER SCHEDULE. Press **HOME**.



Press **HOME** to enter HEATING SCHEDULE. Use **LV** to select the days you wish to change. Press **HOME**.



Use **▲▼** to change the times and temperatures & **HOME** to confirm and move to the next time/temperature. Use **HOME** to save your Programs.

Repeat these steps until all programs have been set. Press **HOME** to save

Setting Hot Water Programs



Press **HOME** to wake the display Press **MENU** & use **▲▼** to navigate to HEATING AND HOT WATER SCHEDULE. Press **HOME**.

Use **▲▼** to select HOT WATER SCHEDULE. Press **HOME** & Use **▲▼** to select the days you wish to change. Press **HOME**.



Use **▲▼** to set your 1st HOT WATER start time. Press **HOME** & use **▲▼** to set your 1st HOT WATER end time. Press **HOME**.

Repeat these steps until you have set all programs. Press **HOME** to save your settings & use the **RETURN BUTTON** to exit the menu.

Number of Programs

Your ESI STRATUS can run either 4 or 6 daily programs.



Press **HOME** to wake the display. HOLD the **MENU** until the display shows RF SETUP.

Use **▲▼** to choose either 4 or 6 programs. Press **HOME** to save.

Display Settings - Brightness



Press **HOME** to wake the display, then press **MENU**. Use **▲▼** to navigate to DISPLAY. Press **HOME**.

Press **HOME** to enter brightness settings.



Use **▲▼** to change the brightness level. Press **HOME** to save. Use the **RETURN BUTTON** to get back to your HOME SCREEN.

Display Settings - Brightness



Press **HOME** to wake the display. Tap the **MENU** button. Use **▲▼** until the screen shows **DISPLAY**. Tap the **HOME** button.

Press **HOME** to enter the Brightness option. Use **▲▼** to adjust the display brightness.

When you have chosen your Brightness, use the **RETURN BUTTON** to get back to your HOME SCREEN.

Display Settings – Display Mode

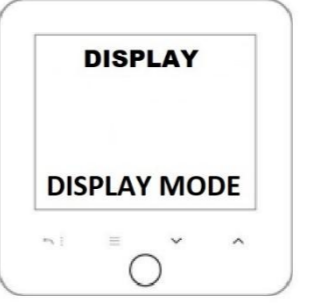

Press **HOME** to wake the display. Tap the **MENU** button. Use **▲▼** until the screen shows **DISPLAY**. Tap the **HOME** button.

Use **▲▼** to select DISPLAY MODE. Tap the **HOME** button to enter DISPLAY MODE settings.

Use **▲▼** to tap **HOME** to choose from the Following options:
COMPLETE will show the set temperature, current room temperature, program & time.
CLOCK will show the current room temperature and the current time.
BASIC will show only the current room Temperature.
SIMPLE will show the set temperature, current room temperature and program mode.

When you have chose a display mode, use the **RETURN BUTTON** to get back to HOME.

Display Settings - Standby



Press **HOME** to wake the display. Tap the **MENU** button. Use **▲▼** until the screen shows **DISPLAY**. Tap the **HOME** button.

Use **▲▼** to select STANDBY. Press **HOME** to enter the STANDBY option. Use **▲▼** to select between the following options.

DIMMED – the display will dim after 15 seconds if no buttons are pressed.
NORMAL – the display will stay on continuously.
OFF – the display will go blank after around 15 seconds.

When you have chosen your Brightness, tap **HOME** to select and use the **RETURN BUTTON** to get back to your HOME SCREEN

Holiday Mode

Holiday mode will let you set a minimum temperature for the duration of your holiday. When Holiday Mode is set no programs will run.



Press **HOME** to wake the display. Press **MENU** and use **▲▼** to navigate to HOLIDAY SETUP. Press **HOME**.

Use **▲▼** to enter the number of days you expect to be away. Press **HOME**.



Use **▲▼** to set a minimum temperature while you are away. Press **HOME**.

Holiday Mode will start immediately. The display will show the number of days remaining until Holiday Mode ends. When Holiday Mode ends, HOME Mode will resume.

To cancel Holiday Mode at any time, tap the **HOME** button to wake the display, then tap the **HOME** button twice.

Pairing With The ESi Centro App

You can use your smartphone or tablet to regulate your heating by downloading the ESi Centro app. Simply follow the instructions on the app to pair your thermostat to your home network.

Warning: Interference with sealed parts renders the warranty void.

In the interests of continuous product improvement, we reserve the right to alter designs, specifications and materials without prior notice and cannot accept liability for errors.



Energy Saving Innovative Controls Limited

www.esicontrols.co.uk

We are continuously developing our products to bring you the very latest in energy saving technology and simplicity. However, should you have any questions regarding setting up your controls please email us at tech@esicontrols.co.uk